

High Power RF LDMOS Field Effect Transistor 10 W, 1.0 – 2.0 GHz

Description

The PTF180101M is an unmatched 10-watt *GOLDMOS*® FET intended for class AB base station applications in the 1 to 2 GHz band. This LDMOS device offers excellent gain, efficiency and linearity performance in a small footprint.



PTF180101M
Package PG-RFP-10

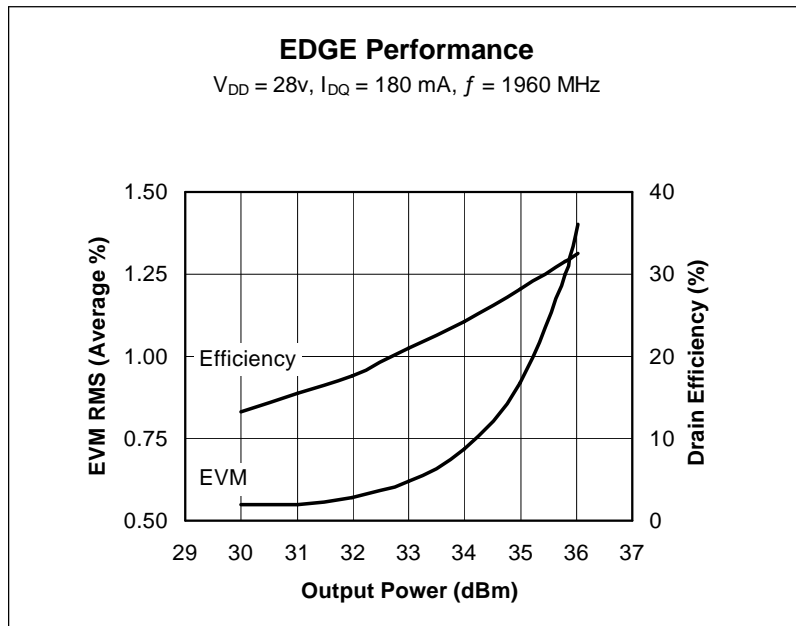

Features

- Typical EDGE performance
 - Average output power = 4.0 W
 - Gain = 17 dB
 - Efficiency = 31%
 - EVM = 1.3 %
- Typical CW performance
 - Output Power at P-1dB = 10 W
 - Gain = 16 dB
 - Efficiency = 50%
- Integrated ESD protection: Human Body Model Class 1 (minimum)
- Excellent thermal stability
- Low HCI drift
- Capable of handling 10:1 VSWR @ 28 V, 10 W (CW) output power
- Pb-free and RoHS compliant

RF Characteristics

Two-Tone Measurements (not subject to production test—verified by design/characterization in Infineon test fixture)

$V_{DD} = 28\text{ V}$, $I_{DQ} = 180\text{ mA}$, $P_{OUT} = 10\text{ W PEP}$, $f = 1990\text{ MHz}$, tone spacing = 1 MHz

Characteristic	Symbol	Min	Typ	Max	Unit
Gain	G_{ps}	16.5	—	—	dB
Drain Efficiency	η_D	35	—	—	%
Intermodulation Distortion	IMD	—	—	-28	dBc

All published data at $T_{CASE} = 25^\circ\text{C}$ unless otherwise indicated

ESD: Electrostatic discharge sensitive device—observe handling precautions!

DC Characteristics

Characteristic	Conditions	Symbol	Min	Typ	Max	Unit
Drain-Source Breakdown Voltage	$V_{GS} = 0\text{ V}, I_{DS} = 10\ \mu\text{A}$	$V_{(BR)DSS}$	65	—	—	V
Drain Leakage Current	$V_{DS} = 28\text{ V}, V_{GS} = 0\text{ V}$	I_{DSS}	—	—	1.0	μA
On-State Resistance	$V_{GS} = 10\text{ V}, V_{DS} = 0.1\text{ A}$	$R_{DS(on)}$	—	0.83	—	Ω
Operating Gate Voltage	$V_{DS} = 28\text{ V}, I_{DQ} = 180\text{ mA}$	V_{GS}	2.5	3.2	4.0	V
Gate Leakage Current	$V_{GS} = 10\text{ V}, V_{DS} = 0\text{ V}$	I_{GSS}	—	—	1.0	μA

Maximum Ratings

Parameter	Symbol	Value	Unit
Drain-Source Voltage	V_{DSS}	65	V
Gate-Source Voltage	V_{GS}	-0.5 to +12	V
Junction Temperature	T_J	150	$^{\circ}\text{C}$
Total Device Dissipation	P_D	18.8	W
Above 25 $^{\circ}\text{C}$ derate by		0.15	W/ $^{\circ}\text{C}$
Storage Temperature Range	T_{STG}	-40 to +150	$^{\circ}\text{C}$
Thermal Resistance ($T_{CASE} = 70^{\circ}\text{C}, 10\text{ W DC}$)	$R_{\theta JC}$	6.5	$^{\circ}\text{C/W}$

Ordering Information

Type	Package Outline	Package Description	Marking
PTF180101M	PG-RFP-10	Molded plastic, SMD	0181

Typical Performance (data taken in production test fixture)

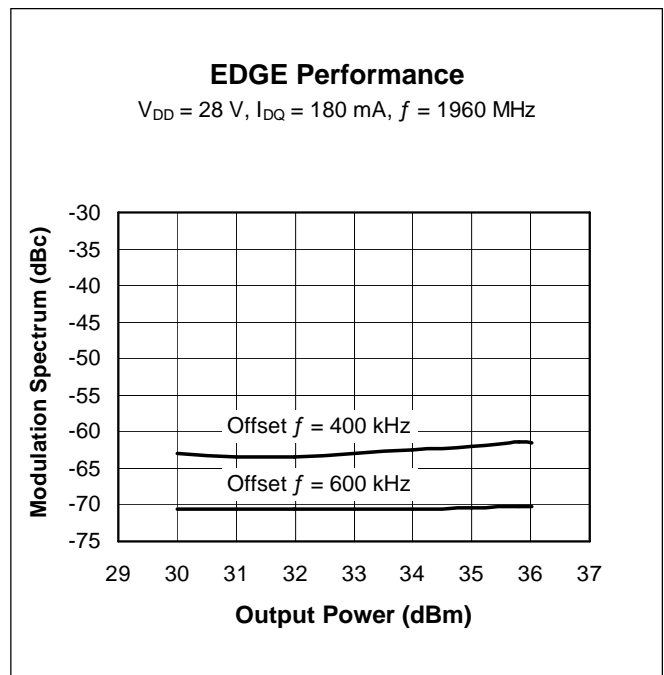
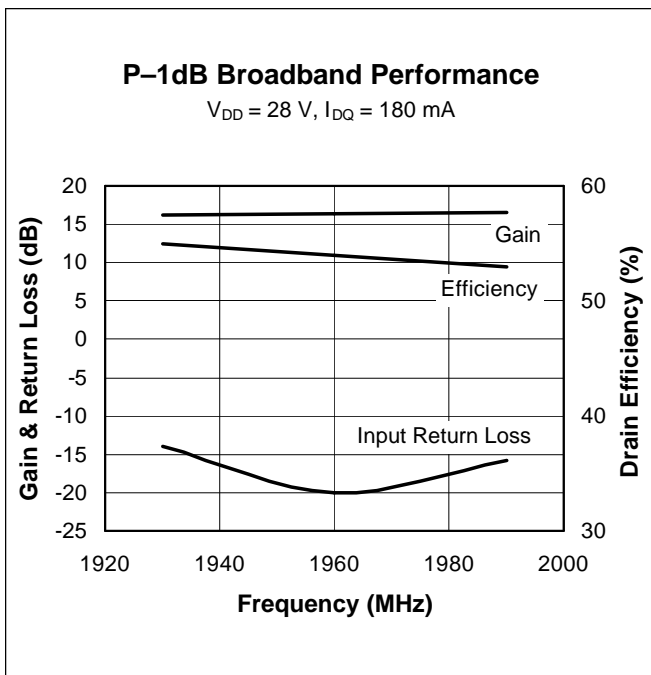
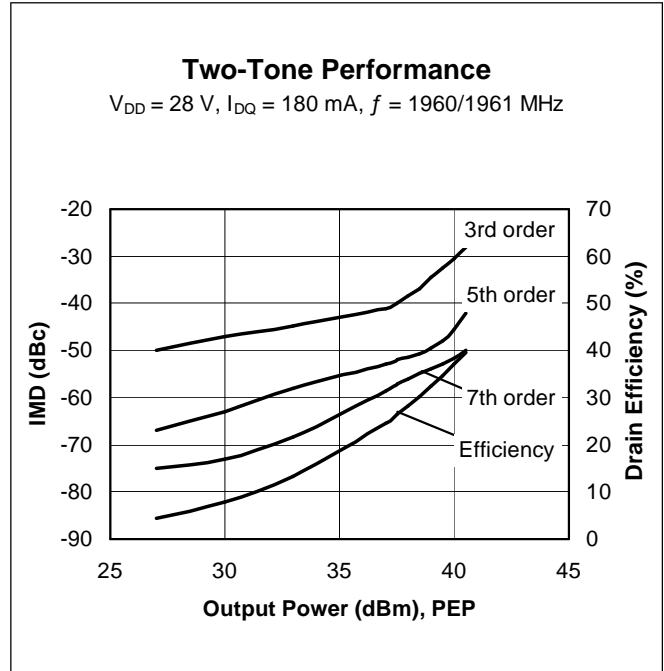
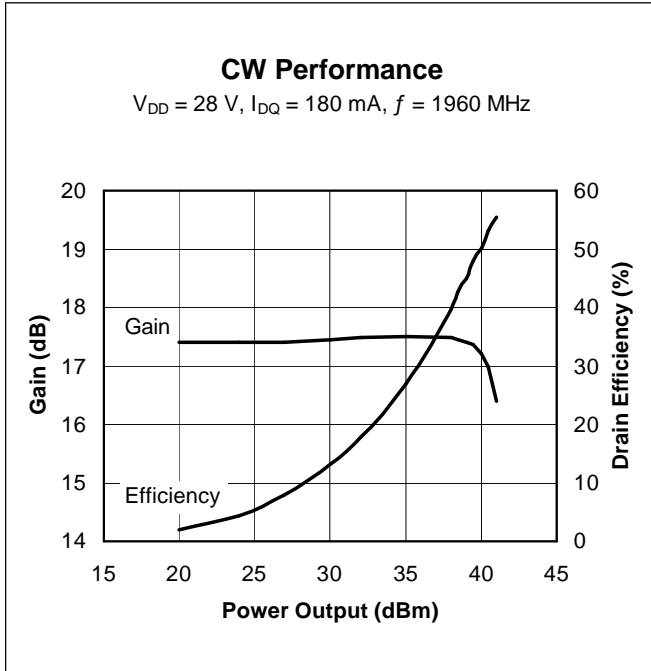

Typical Performance (cont.)

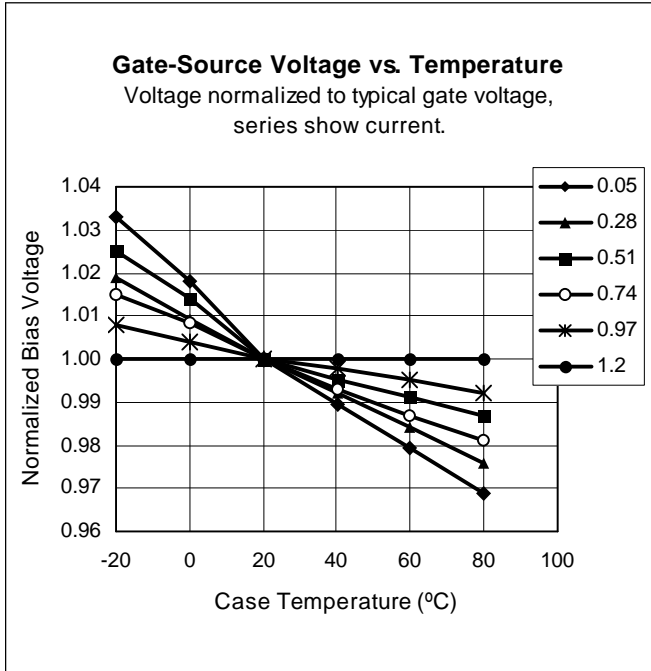

Broadband Circuit Impedance

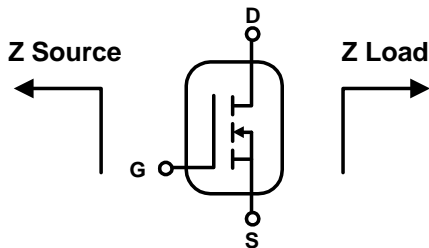

Frequency MHz	Z Source W		Z Load W	
	R	jX	R	jX
1900	0.80	-3.71	2.89	-1.38
1910	0.79	-3.66	2.88	-1.30
1920	0.79	-3.61	2.87	-1.21
1930	0.78	-3.56	2.85	-1.13
1940	0.77	-3.51	2.84	-1.05
1950	0.77	-3.47	2.82	-0.97
1960	0.76	-3.42	2.81	-0.89
1970	0.75	-3.37	2.80	-0.81
1980	0.75	-3.33	2.78	-0.73
1990	0.74	-3.28	2.77	-0.65
2000	0.74	-3.24	2.76	-0.57

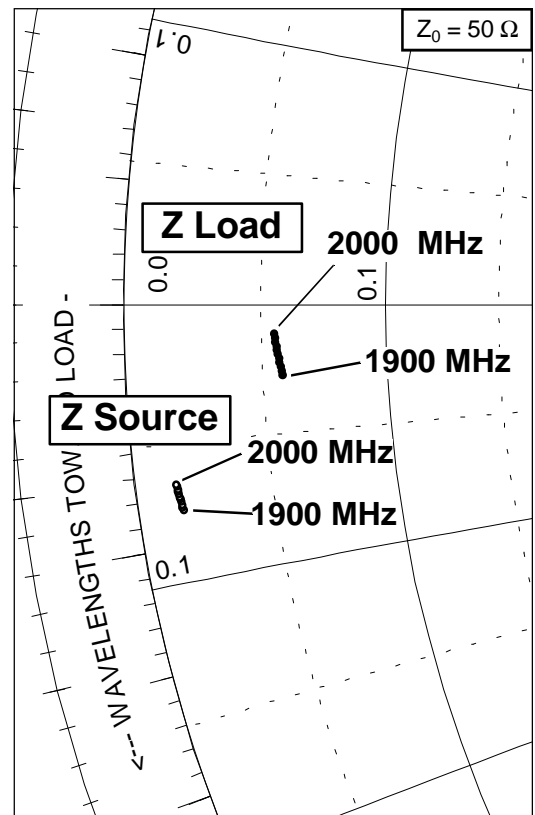

Reference Circuit

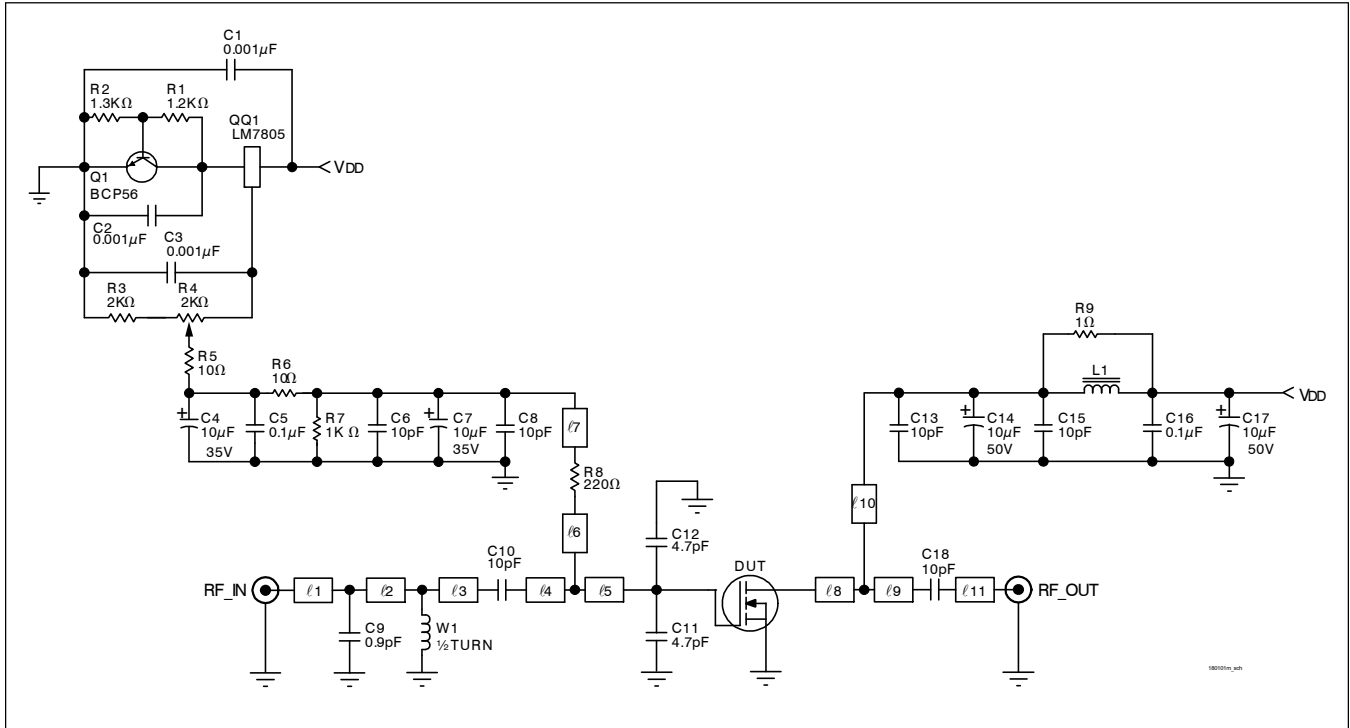

Reference circuit schematic for $f = 1990 \text{ MHz}$

Circuit Assembly Information

DUT	PTF180101M	LDMOS Transistor	
PCB	0.76 mm [.030"] thick, $\epsilon_r = 4.5$	Rogers RO4320	2 oz. copper

Microstrip	Electrical Characteristics at 1990 MHz ¹	Dimensions: L x W (mm)	Dimensions: L x W (in.)
l1	0.059 λ , 50.0 Ω	5.69 x 1.60	0.224 x 0.063
l2	0.093 λ , 50.0 Ω	8.48 x 1.60	0.334 x 0.063
l3	0.016 λ , 50.0 Ω	1.09 x 1.60	0.043 x 0.063
l4	0.129 λ , 9.6 Ω	10.77 x 14.22	0.424 x 0.560
l5	0.026 λ , 9.6 Ω	2.13 x 14.22	0.084 x 0.560
l6	0.153 λ , 78.0 Ω	14.48 x 0.71	0.570 x 0.028
l7	0.194 λ , 78.0 Ω	18.39 x 0.71	0.724 x 0.028
l8	0.014 λ , 12.9 Ω	1.27 x 10.16	0.050 x 0.400
l9	0.236 λ , 12.9 Ω	19.91 x 10.16	0.784 x 0.400
l10	0.187 λ , 66.0 Ω	17.40 x 0.99	0.685 x 0.039
l11	0.077 λ , 50.0 Ω	6.99 x 1.60	0.275 x 0.063

¹Electrical characteristics are rounded.

Reference Circuit (cont.)

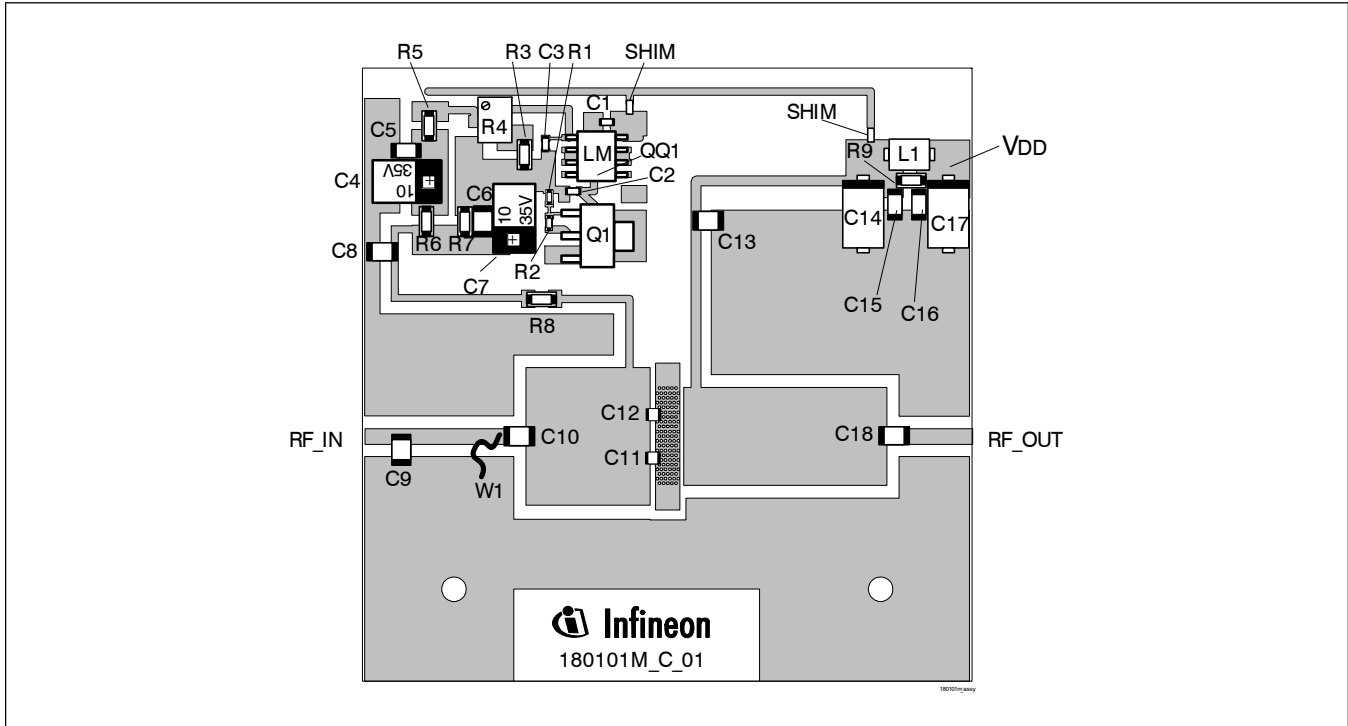

Reference circuit assembly diagram (not to scale)*

Component	Description	Suggested Manufacturer	P/N or Comment
C1, C2, C3	Capacitor, 0.001 μ F	Digi-Key	PCC1772CT-ND
C4, C7	Tantalum capacitor, 10 μ F, 35 V	Digi-Key	PCS6106TR-ND
C5, C16	Capacitor, 0.1 μ F	Digi-Key	PCC104BCT-ND
C6, C8, C10, C13, C15, C18	Ceramic capacitor, 10 pF	ATC	100B 100
C9	Ceramic capacitor, 0.9 pF	ATC	100B 0R9
C11, C12	Ceramic capacitor, 4.7pF	ATC	100B 4R7
C14, C17	Tantalum capacitor, 10 μ F, 50 V	Digi-Key	TPSE106K050R0400
L1	Ferrite, 4mm	Elna Magnetics	BDS3/3/4.6-4S2
Q1	Transistor	Infinion Technologies	BCP56
QQ1	Voltage regulator	National Semiconductor	LM7805
R1	Chip Resistor 1.2 k-ohms	Digi-Key	P1.2KGCT-ND
R2	Chip Resistor 1.3 k-ohms	Digi-Key	P1.3KGCT-ND
R3	Chip Resistor 2 k-ohms	Digi-Key	P2KECT-ND
R4	Potentiometer 2 k-ohms	Digi-Key	3224W-202ETR-ND
R5, R6	Chip Resistor 10 ohms	Digi-Key	P10ECT-ND
R7	Chip Resistor 1 k-ohms	Digi-Key	P1KECT-ND
R8	Chip Resistor 220 ohms	Digi-Key	P221ECT-ND
W1	Wire 0.250"	N/A	AUG22, SOLID

*Gerber Files for this circuit available on request

Package Outline Specifications

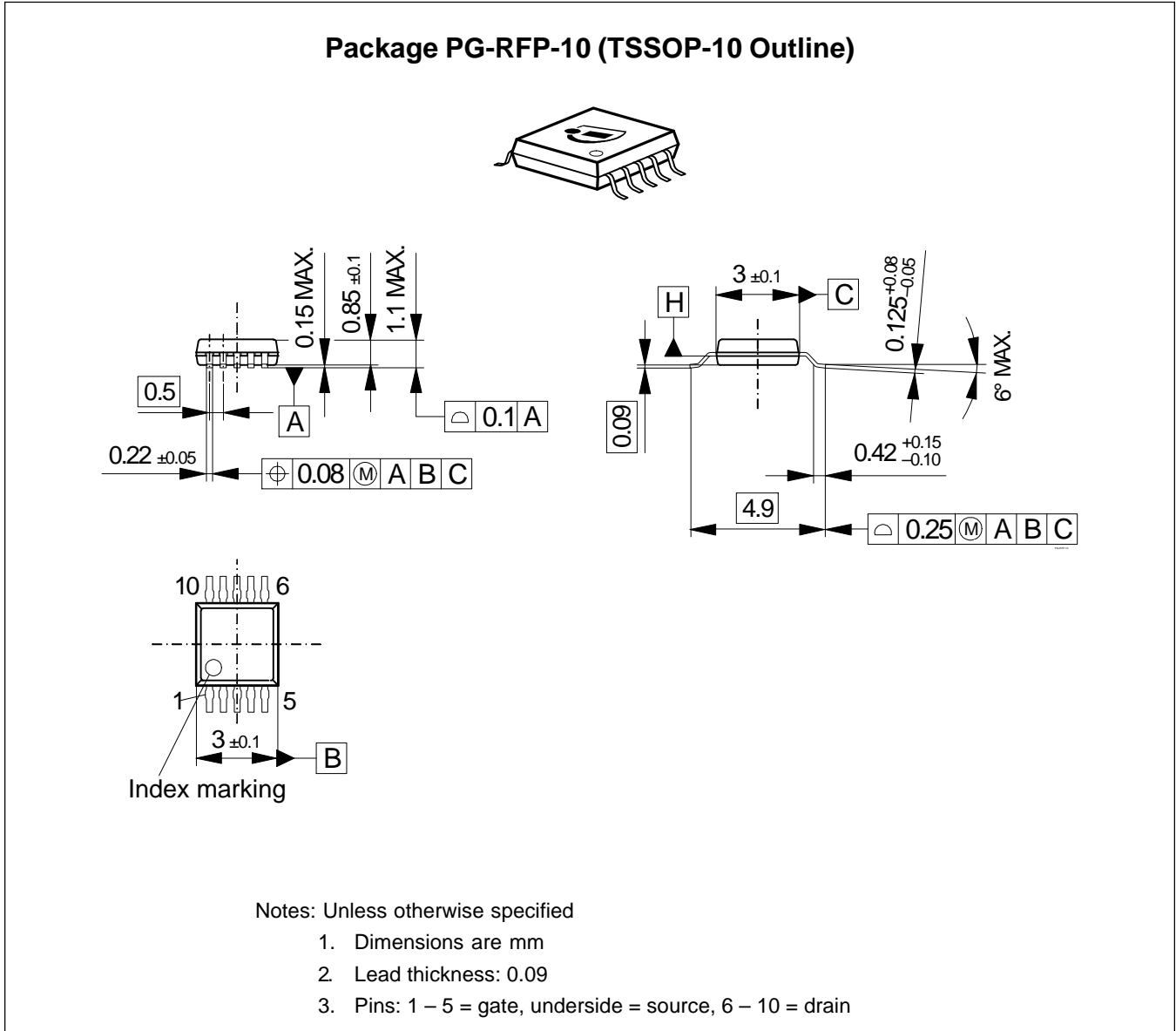

Find the latest and most complete information about products and packaging at the Infineon Internet page <http://www.infineon.com/products>

Revision History: 2005-12-06 Data Sheet

Previous version: 2005-11-14, Preliminary Data Sheet

Page	Subjects (major changes since last revision)
all	Remove Preliminary designation

We Listen to Your Comments

Any information within this document that you feel is wrong, unclear or missing at all?
 Your feedback will help us to continuously improve the quality of this document.
 Please send your proposal (including a reference to this document) to:

highpowerRF@infineon.com

To request other information, contact us at:
 +1 877 465 3667 (1-877-GOLDMOS) USA
 or +1 408 776 0600 International

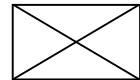

GOLDMOS® is a registered trademark of Infineon Technologies AG.

Edition 2005-12-06

**Published by Infineon Technologies AG,
 St.-Martin-Strasse 53,
 81669 München, Germany**

**© Infineon Technologies AG 2004.
 All Rights Reserved.**

Attention please!

The information herein is given to describe certain components and shall not be considered as a guarantee of characteristics.

Terms of delivery and rights to technical change reserved.

We hereby disclaim any and all warranties, including but not limited to warranties of non-infringement, regarding circuits, descriptions and charts stated herein.

Information

For further information on technology, delivery terms and conditions and prices please contact your nearest Infineon Technologies Office (www.infineon.com/rfpower).

Warnings

Due to technical requirements components may contain dangerous substances. For information on the types in question please contact your nearest Infineon Technologies Office.

Infineon Technologies Components may only be used in life-support devices or systems with the express written approval of Infineon Technologies, if a failure of such components can reasonably be expected to cause the failure of that life-support device or system, or to affect the safety or effectiveness of that device or system. Life support devices or systems are intended to be implanted in the human body, or to support and/or maintain and sustain and/or protect human life. If they fail, it is reasonable to assume that the health of the user or other persons may be endangered.